

3.2. Претензии от покупателя принимаются торговыми организациями в течении гарантийного срока - 24 месяца со дня приобретения.

3.3. Претензии не принимаются по дефектам, возникшим по причине несоблюдения покупателем правил по сборке, эксплуатации и уходу за мебелью.

Левый

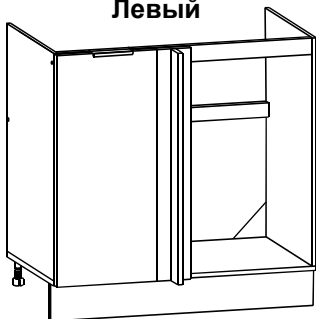

Правый



Таблица комплектности деталей

Пачка	Деталь	Поз	Размеры			К-во, шт
			Д	Ш	Т	
1	Стенка боковая	2	704	460	16	2
1	Стенка нижняя	6	750	460	16	1
1	Планка цокольная	10	718	80	16	2
1	Цоколь	4	750	98	16	1
1	Цоколь	4	70	98	16	2
1	Планка вертикальная	9	720	100	16	1
1	Планка вертикальная	5	720	25	16	1
1	Дверь	17	713	296	16	1

Потребуется для сборки



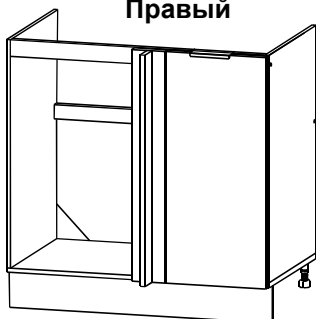







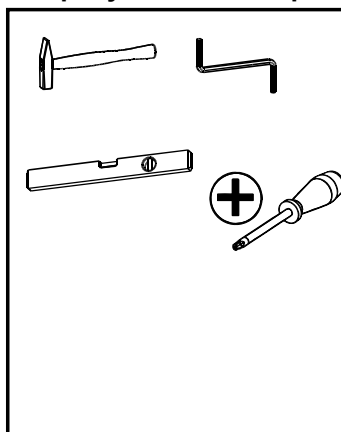







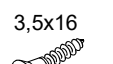

Таблица комплектности фурнитуры

A  x4	Б  x8	В  x1	Г  x2	Д  x2
Е  x1	И  x4	К 3,5x16  x23	Л 4x35  x2	М  x4
Н 4x30  x2	П  x12	Р  x6	С  x4	Т  x4
У  x1	Ч  3,5x12 x2	Х  x4		

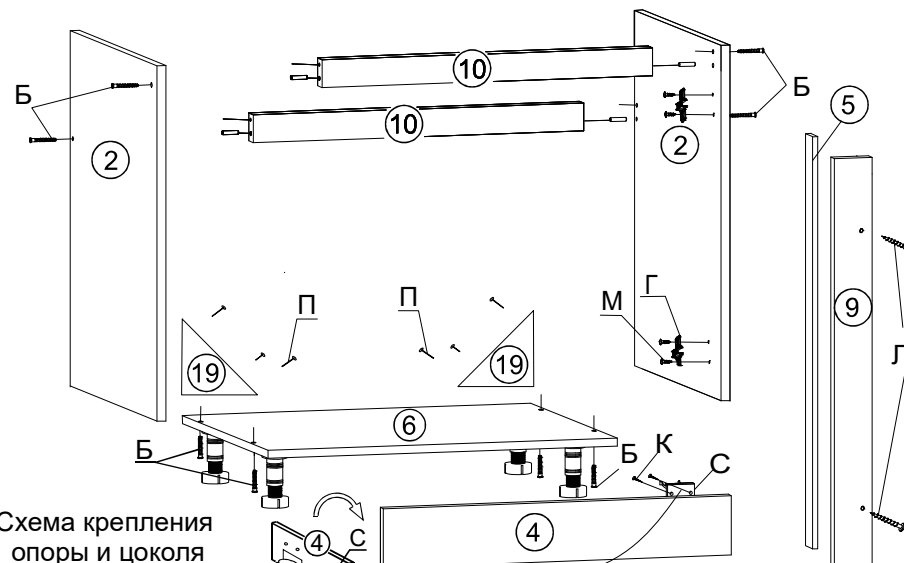

Схема крепления опоры и цоколя

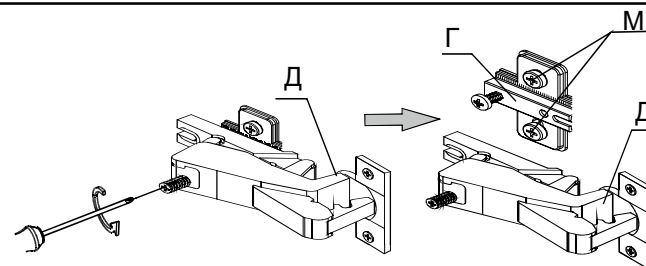
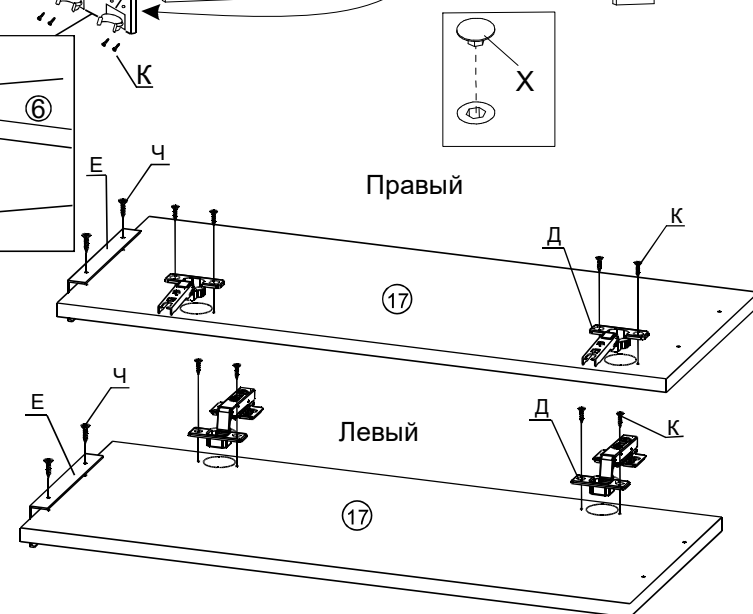
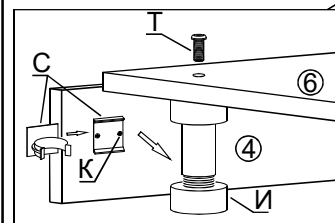

Правый

Левый